

BJERRING

A thick, red, brushstroke-style underline that starts under the 'E' and extends to the right, ending under the 'G'. It has a slightly irregular, hand-painted appearance.

SunSwim[®] Alu-Top BJERRING

SunSwim Manuel Hæve/Sænke Scene



Klik ind på www.bjerring-sales.dk og se mere

BJERRING

SunSwim[®] Alu-Top

Manuel Hæve/Sænke Scene

Lundtofte Skole Kongens Lyngby

| | |
|--------------------------|-----------------------------------|
| Scene bredde | 8 m |
| Scene dybde | 4 m |
| Max scenehøjde | 80 cm |
| Scene højder/stop | 20 – 40 – 60 – 80 cm |
| Pit dybde min. | 230 mm |
| Belastning | 750 kg/m² |
| Overflade: | Special plader med klinker |

BJERRING

SunSwim® Alu-Top Manuel Hæve/Sænke Scene

Lundtofte Skole



BJERRING

SunSwim® Alu-Top Manuel Hæve/Sænke Scene

Lundtofte Skole



BJERRING

SunSwim® Alu-Top Manuel Hæve/Sænke Scene

Lundtofte Skole



BJERRING

SunSwim® Alu-Top Manuel Hæve/Sænke Scene

Lundtofte Skole



BJERRING

SunSwim® Alu-Top Manuel Hæve/Sænke Scene

Lundtofte Skole



BJERRING

SunSwim[®] Alu-Top Manuel Hæve/Sænke Scene

Lundtofte Skole

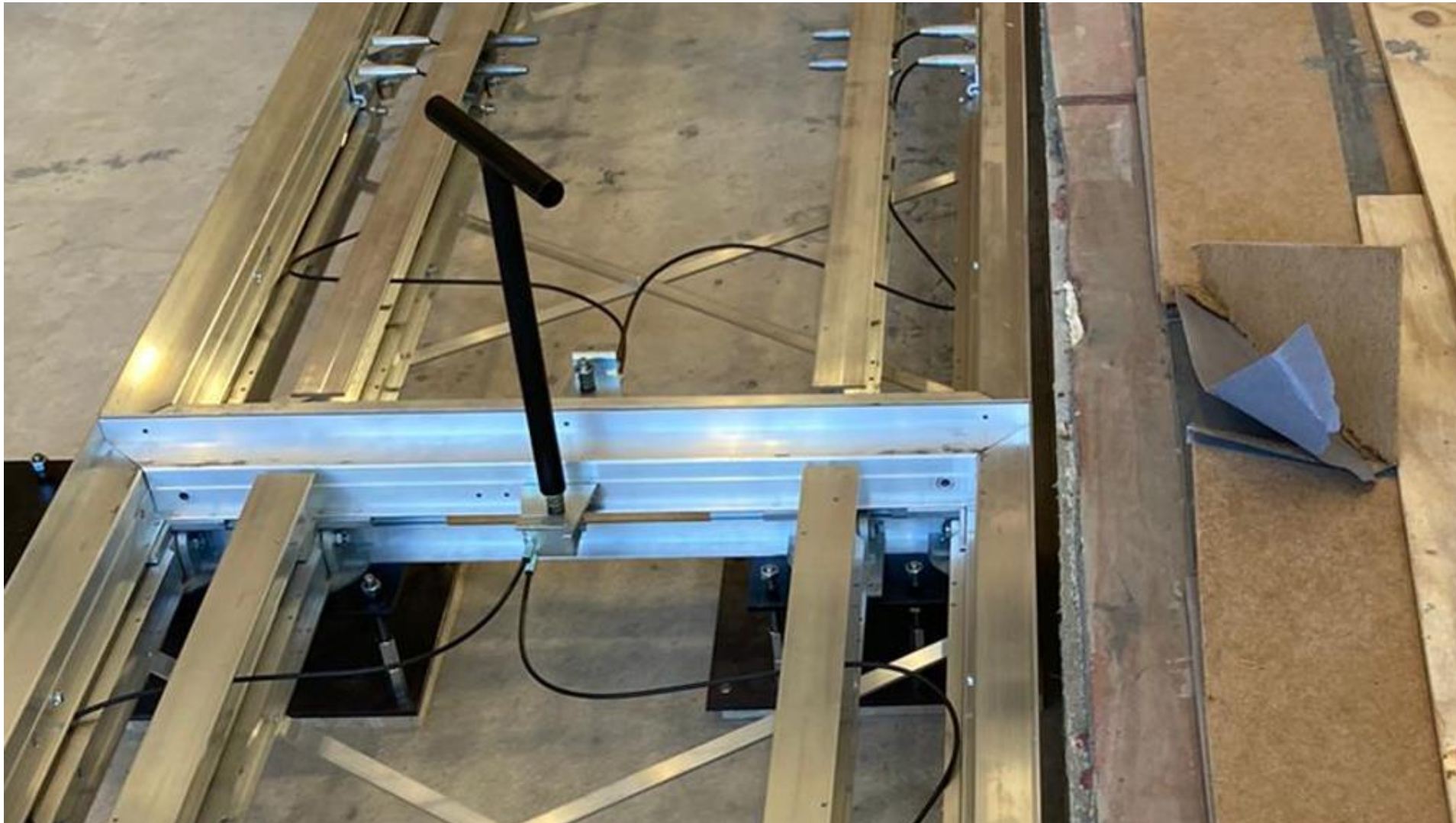

BJERRING

SunSwim® Alu-Top Manuel Hæve/Sænke Scene

Lundtofte Skole



BJERRING

SunSwim® Alu-Top Manuel Hæve/Sænke Scene

Lundtofte Skole



BJERRING

SunSwim[®] Alu-Top Manuel Hæve/Sænke Scene

Lundtofte Skole



BJERRING

SunSwim® Alu-Top Manuel Hæve/Sænke Scene

Lundtofte Skole



BJERRING

SunSwim[®] Alu-Top Manuel Hæve/Sænke Scene

Lundtofte Skole

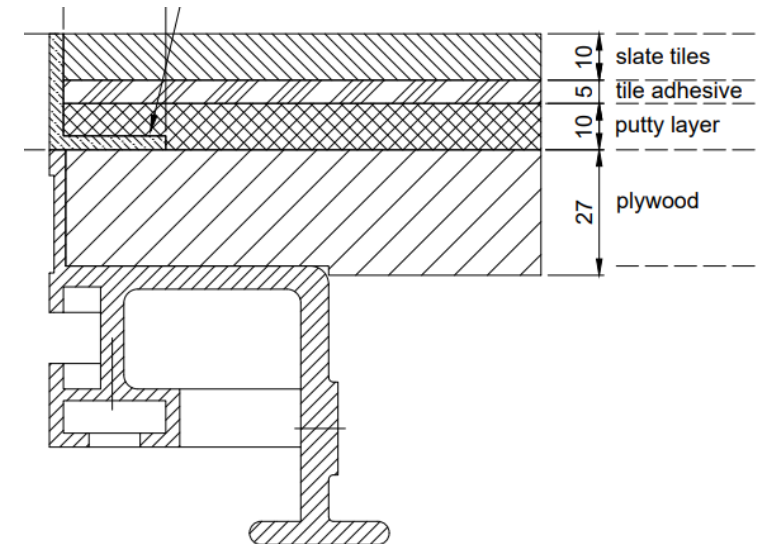
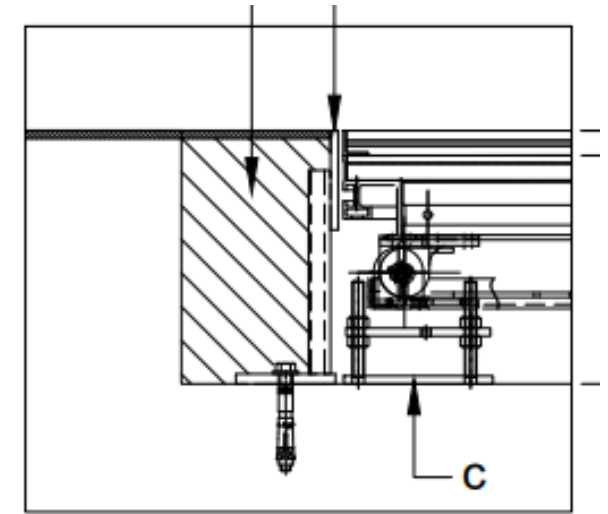
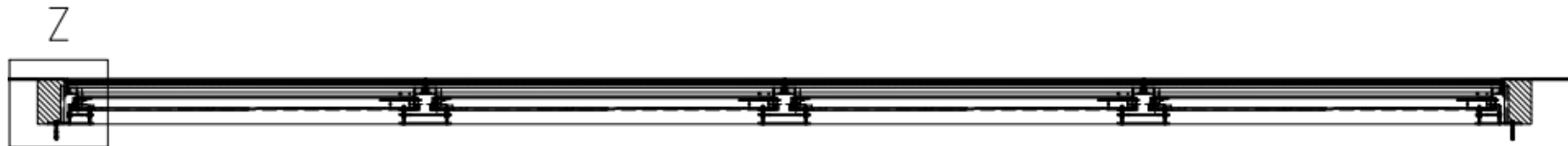
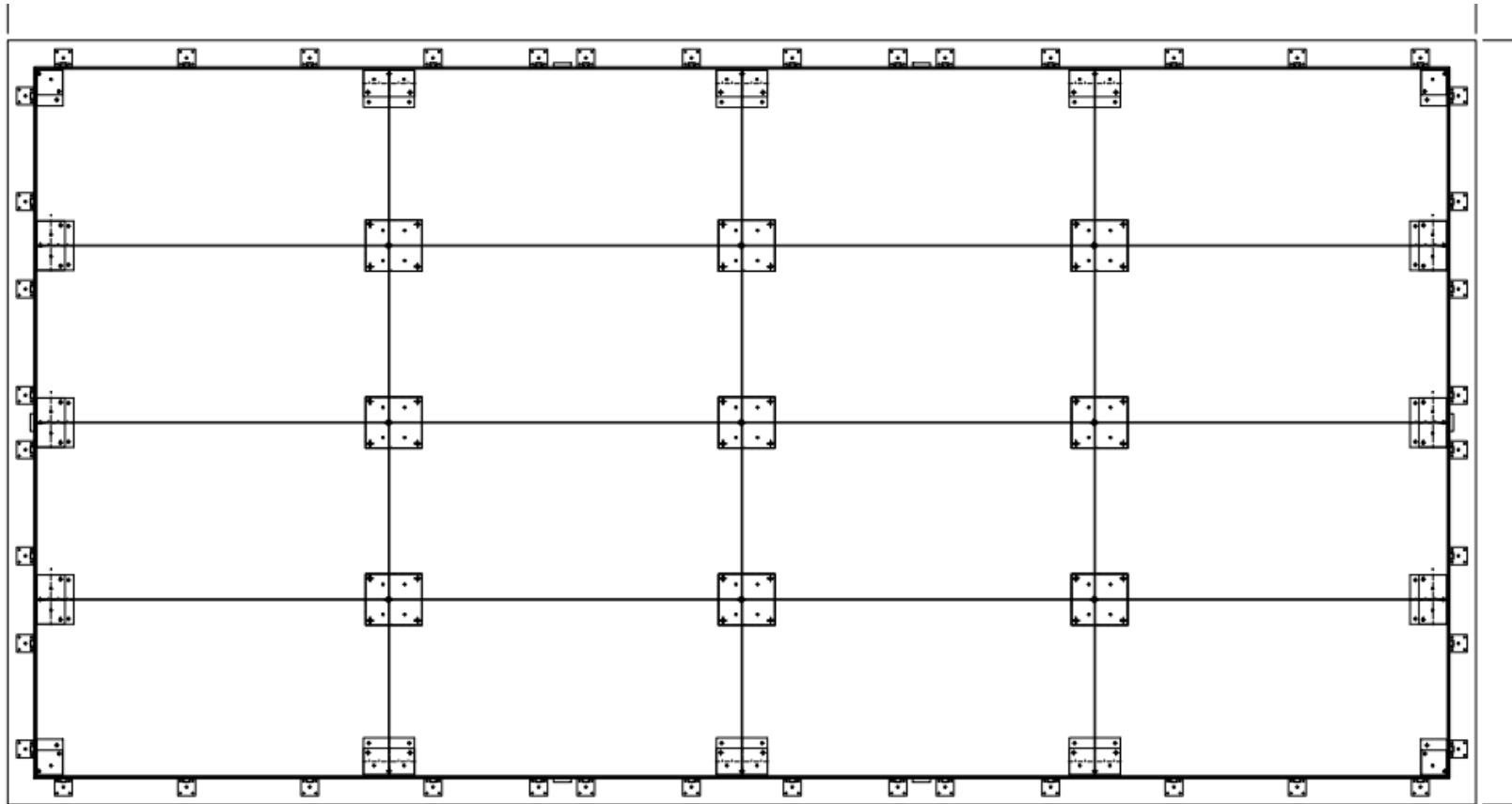

SunSwim[®] Alu-Top

Manuel Hæve/Sænke Scene

Handelsskolen Skanderborg

| | |
|--------------------------|-----------------------------|
| Scene bredde | 6 m |
| Scene dybde | 4 m |
| Max scenehøjde | 80 cm |
| Scene højder/stop | 20 – 40 – 60 – 80 cm |
| Pit dybde min. | 200 mm |
| Belastning | 750 kg/m² |
| Gulv/Plade: | 25 mm |
| Overflade: | Tæppe eller Linolium |

BJERRING

SunSwim[®] Alu-Top Manuel Hæve/Sænke Scene

Handelsskolen Skanderborg



BJERRING

SunSwim® Alu-Top Manuel Hæve/Sænke Scene

Handelsskolen Skanderborg



BJERRING

SunSwim® Alu-Top Manuel Hæve/Sænke Scene

Handelsskolen Skanderborg



BJERRING

SunSwim® Alu-Top Manuel Hæve/Sænke Scene

Handelsskolen Skanderborg



SunSwim[®] Alu-Top BJERRING

SunSwim Manuel Hæve/Sænke Scene



Klik ind på www.bjerring-sales.dk og se mere

BJERRING

SunSwim® Alu-Top Manuel Hæve/Sænke Scene

Special produktion



BJERRING

SunSwim® Alu-Top Manuel Hæve/Sænke Scene

Special produktion

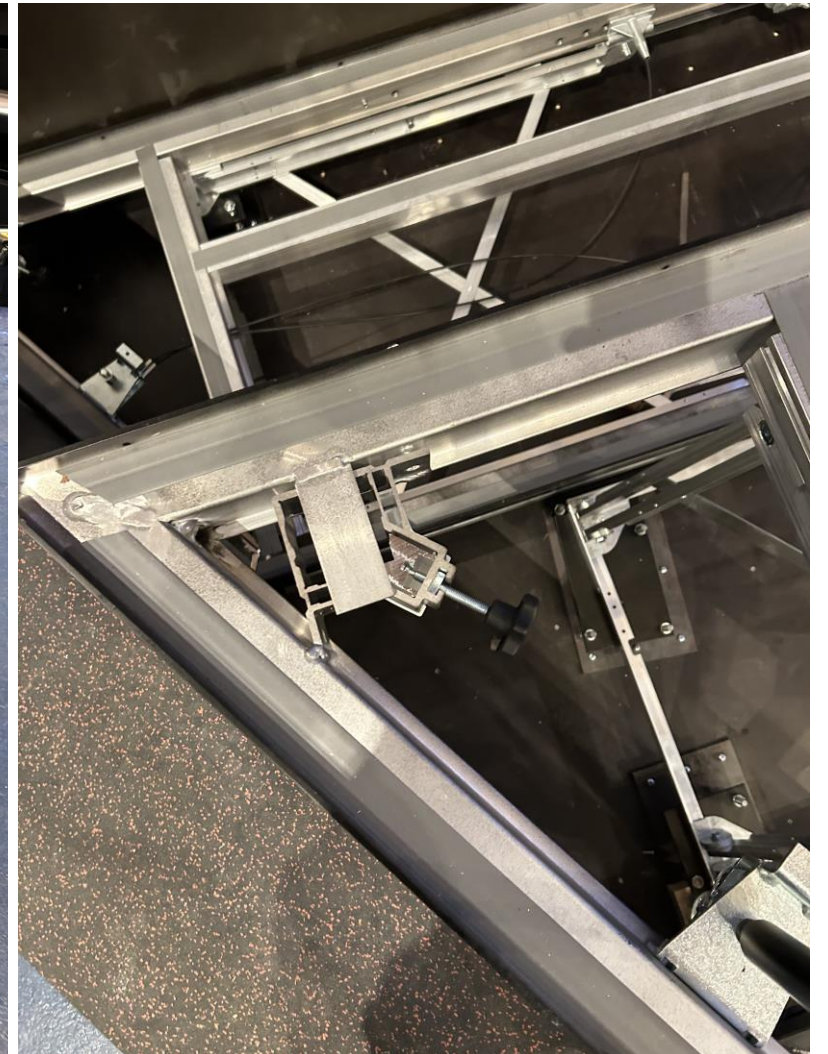

BJERRING

SunSwim® Alu-Top Manuel Hæve/Sænke Scene

Diverse

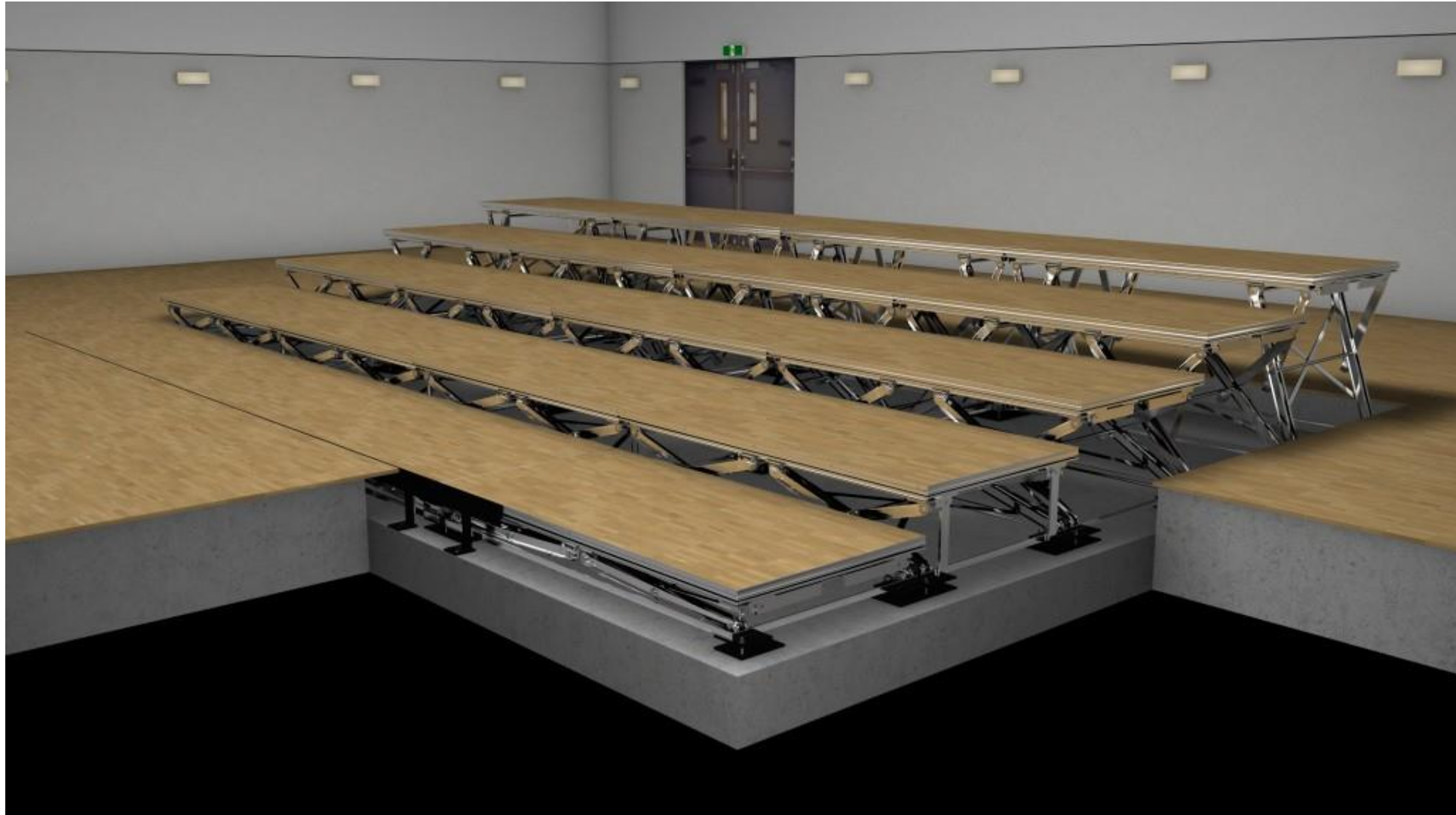

BJERRING

SunSwim® Alu-Top Manuel Hæve/Sænke Scene

Diverse

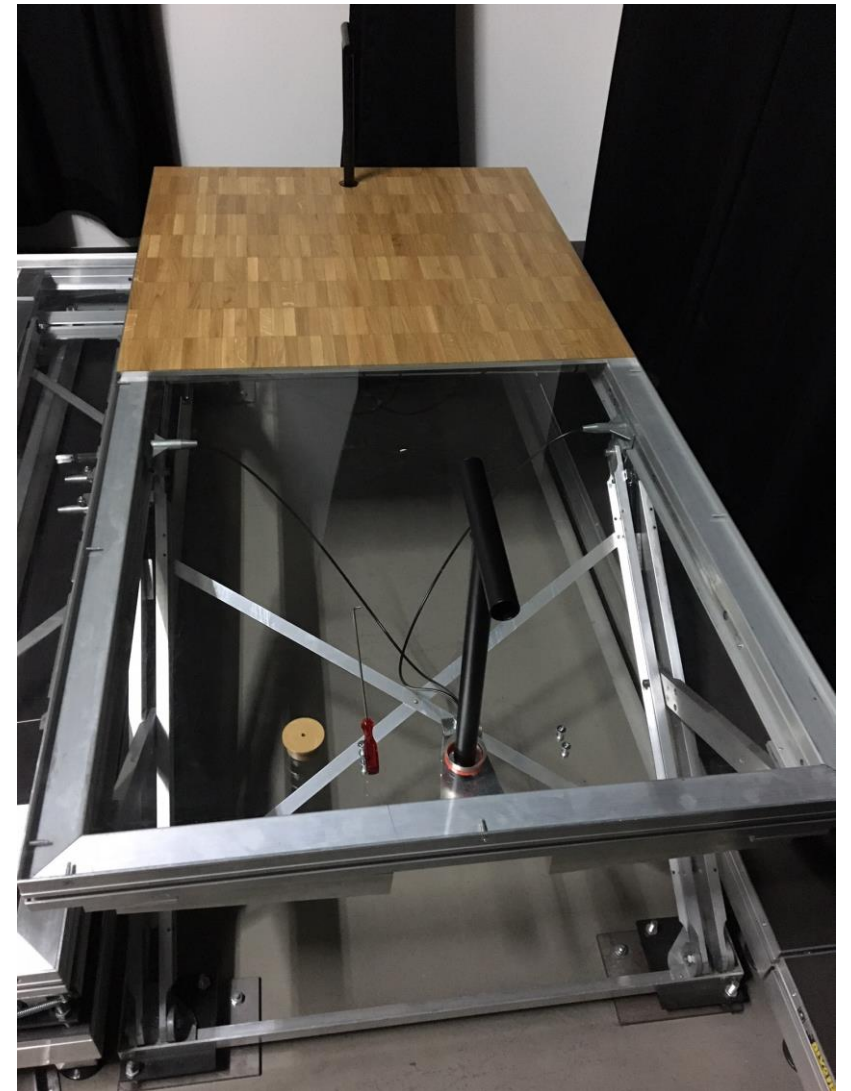

BJERRING

SunSwim® Alu-Top Manuel Hæve/Sænke Scene

Diverse



BJERRING



Kontakt os på:

TLF: +45 77345206

[Mail: salg@bjerring-sales.dk](mailto:salg@bjerring-sales.dk)

Se mere på: www.bjerring-sales.dk

www.sunswim.dk – www.bjerring-shop.dk